

ROCKVILLE

RockGhost 8" 800W POWERED CAR SUBWOOFER

OWNER'S MANUAL

WHO READS MANUALS?

Instead, go to vimeo.com/showcase/6761895 or scan the QR code and watch a short informational videos concerning set-up and usage.

If you prefer written instructions please read ahead!

With Rockville we offer many options.

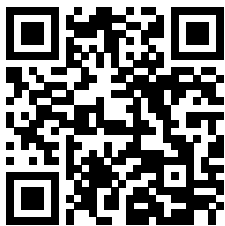

Missing items? If you ordered a bundle that includes more than one product and you are missing part of your bundle, then it just means your order shipped from two different warehouses. You will receive the remaining items very soon. If you have any concerns or inquiries, feel free to call our customer support center at 1-646-758-0144, Monday through Thursday, 9am to 10pm EST, and Fridays, 9am to 3pm EST.

ROCKVILLE

Thank you for purchasing this Rockville RockGhost 8" Powered Car Subwoofer. This sub enclosure is only 5.7" tall and fits perfectly inside of your spare tire. It takes up no trunk space! The amplifier is built-in, so installation is clean and simple. This a true all-in-one solution to give you great sounding bass in your vehicle while taking up no space. Please read this owner's manual carefully for proper use of your RockGhost subwoofer. Should you need assistance, please call our technical help line at 1-646-758-0144, Monday through Thursday, 9am to 10pm EST, and Fridays, 9am to 3pm EST.

IMPORTANT SAFETY INSTRUCTIONS



- To reduce risk of electric shock, never open the unit. There are no user serviceable parts, refer service to an authorized Rockville service center.
- Do not expose this unit to any kind of moisture.
- Please ensure that the unit is situated in a properly ventilated area.

Functions

Control Panel

1. Power/Protect LEDs: The LED's are located on the left side of the amplifier panel. Both LEDs will be green when the amplifier is receiving proper power, ground and remote volt-ages. The LED labeled PRO will turn red when the amp goes into protection mode.
2. Remote Control Port: Plug in the included remote control to adjust the input gain, bass boost, low pass filter, and phase shift.
3. Power and Signal Input Harness
4. Fuse: Do not use a fuse with a different value than the one provided.

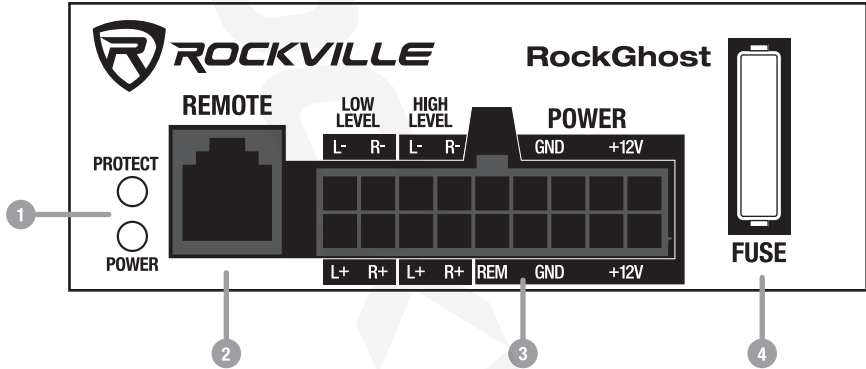

Remote Control

1. Input Gain Control: After you've installed your system, turn this control to minimum. Turn the head unit on (subwoofer will turn on via the remote connection) and set the volume to 2/3 full level. Slowly turn up the subwoofer input gain control until you hear a small amount of distortion. Now reduce the level until the distortion is completely gone. The input gain control is now set.
2. Bass Boost: This control will increase the sound level of the bass frequencies.
3. Low Pass Filter: This control permits you to define the frequency range you want the subwoofer amplifier to receive. The subwoofer will reproduce all sound below the frequency you set.
4. Phase Shift: Use this button to help compensate for time alignment problems. This occurs due to the subwoofer being positioned at a different distance from the listener than the other speakers in the system.

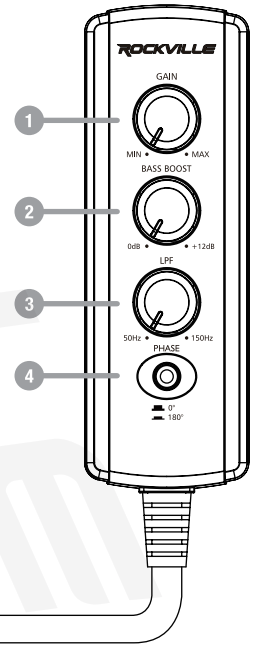

Wiring Harness

1. Low level RCA inputs: Left (white) and Right (red).
2. Left High level input cables: negative (white with black stripe) and positive (white).
3. Right High level input cables: negative (grey with black stripe) and positive (grey).
4. Remote turn-on cable (blue).
5. Ground cable (black)
6. Power cable (red)

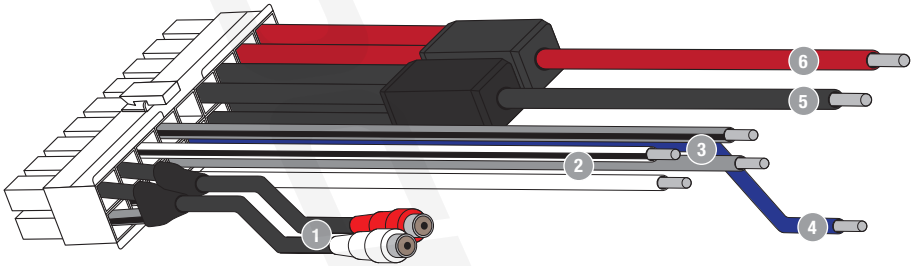

! WARNING: Do not use high level and low level inputs at the same time

! ATTENTION: When using high level inputs, do not connect the blue remote cable.

Wiring Kit

To facilitate your installation, the RockGhost includes an amplifier wiring kit. The kit consist of the following:

- (1) 20ft High Grade Twisted Pair of 100% Copper RCA Cable
- (1) 20ft 10 Gauge Translucent Red Super Flex Power Cable w/In-line Fuse Holder
- (1) 20ft 18 Gauge Blue Remote Cable
- (1) 20ft 16 Gauge Clear Speaker Wire
- (1) 4ft 10 Gauge Translucent Black Super Flex Ground Wire
- (1) 40 Amp ATU In-line Fuse
- (1) 7 Split Tube Loom
- (10) Wire Ties
- (2) Large Ring Terminals
- (4) Large Butt Connectors
- (4) Small Butt Connectors
- (2) Large Spade Terminals
- (4) Small Spade Terminals
- (1) Grommet

All cables feature soft abrasion proof insulating jackets that can with-stand an extreme temperature range of -40 – 220 degrees F.

Power Connections

1. Connect the red +12V cable from the harness to the translucent red power cable. Connect a ring terminal to the end of the cable and connect it to the positive (+) terminal of the vehicle's battery.
2. Connect the ground cable (black) from the harness to the translucent black ground cable. Connect a ring terminal to the end of the cable and connect it to the closest point on the chassis of the vehicle.
3. Connect the remote cable (blue) from the harness to the translucent blue remote cable. Now connect that cable to the remote output of the vehicle's head unit.

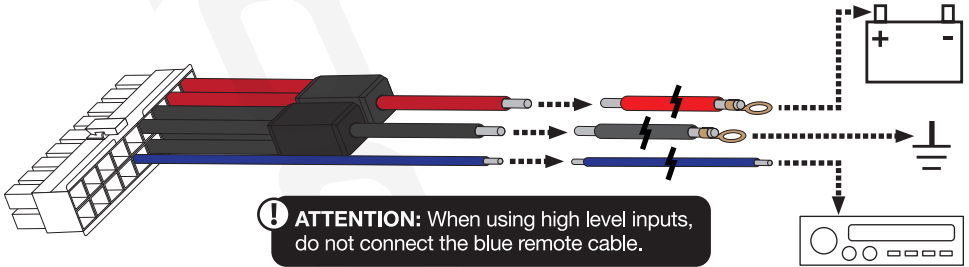

Low Level RCA Input Connections

Low-level (RCA) input wiring is preferred for best audio performance.

Connect the left (white) and right (red) RCA female inputs from the harness to the male RCA interconnects. Connect the other ends to the vehicle's head unit's RCA outputs or subwoofer output (if available).

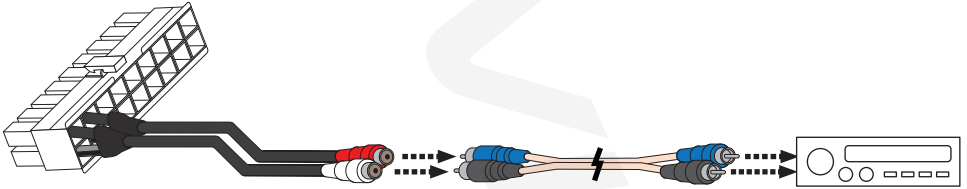

High Level Input Connections

The high level inputs should only be used when your head unit lacks RCA outputs. Splice the high level input leads from the RockGhost harness directly to your head unit's speaker-level outputs. Make sure the blue remote cable is not connected and remember to observe proper polarity in order to avoid audio phase problems.

1. Right speaker: negative (grey with black stripe) and positive (grey)
2. Left speaker: negative (white with black stripe) and positive (white)

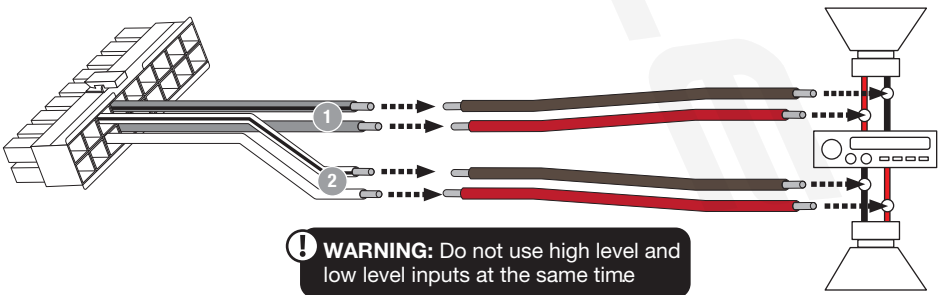

Connecting the Remote Control

Connect the remote to the RJ45 port on the amplifier. Install the remote control securely under the dash or in a similar location where using it will not distract the driver.

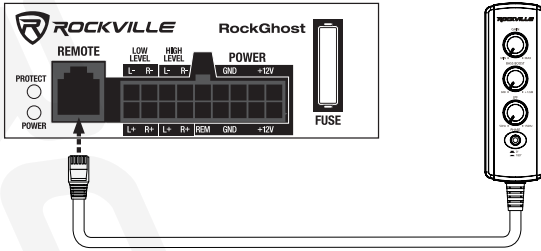

Installation

The RockGhost powered subwoofer is designed to fit in your spare tire. To mount the unit into your spare tire, follow the directions below.

1. Remove the factory retaining bolt and flip the spare tire so that the inside is facing up.
2. Ensure that the unit will fit into your vehicle's spare tire.
3. Carefully place the sub into the spare tire (A). We recommend you make all wiring connections before you placing the sub.
4. Insert the included retaining bolt into the slot at the center of the unit until it reaches the mounting bracket. Turn the screw clockwise to thread it into the bracket (B). Do not over-tighten.

Please note: Some installations may require the use of the included adapter (C)

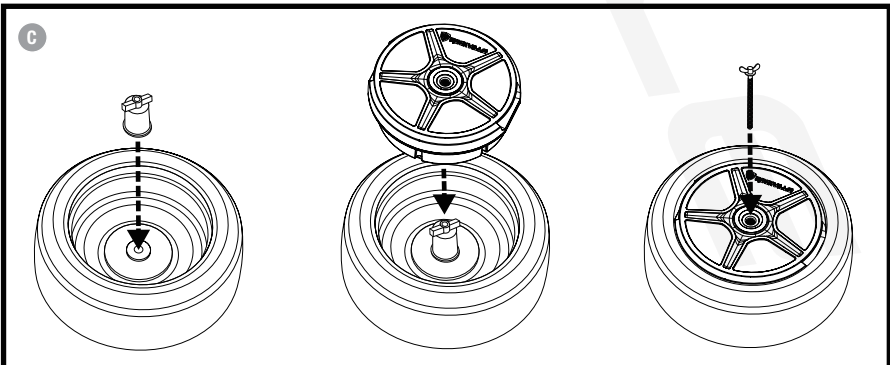
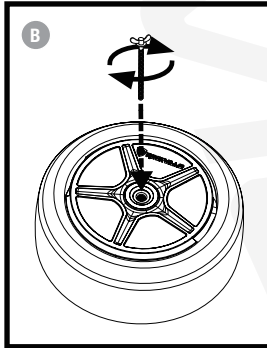
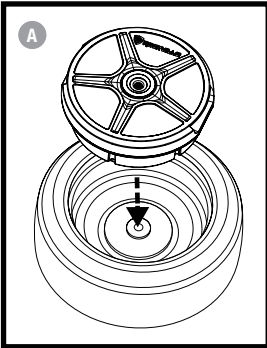

ROCKVILLE

Features and Specifications

- RockGhost perfectly fits inside of your spare tire so it takes up no trunk space (back plate mounts and screws right on top of spare tire).
- It won't get stolen because it's completely hidden. Thieves will not be able to locate it.
- When mounted in your spare tire, the sound transmits cleanly and evenly throughout the vehicle without any vibrations or unwanted noises.
- Extremely loud (enough to vibrate your mirrors)
- Super clean sound that is musical and will not fatigue your ears
- 8" high excursion subwoofer
- Flexible rubber surrounds
- Tunnel air port design
- PWM MOSFET power supply amplifier built-in
- Low level RCA inputs
- Reverse mounting design
- Plug and play installation with wire harness containing power, ground, high level input, remote turn on, and RCA input
- If you wanted you can also mount this in your trunk or under your seat but we recommend mounting it by your spare tire
- Wired 20 foot dash remote with adjustable gain, bass boost, low pass crossover filter, and phase control
- The bass frequency is very deep and clear
- Auto turn on and auto turn off
- Soft Delayed Remote Turn-On
- Thermal Protection Circuit, Short Protection Circuit and Overload Protection Circuit
- Cast aluminum casing
- Adjustable Input Sensitivity

Specifications

- 800 Watts Peak output/200 Watts RMS output
- Phase Switch: 0° or 180°
- Low Pass Filter: 50Hz – 150Hz
- Is Bass Boost: 0 – 12dB @ 45Hz
- 20 Hz Subsonic Filter
- Frequency response: 20Hz – 150Hz
- Signal to Noise Ratio >90dB
- Input sensitivity: 0.4V (low level)/1.0V (high level)
- Requires 10 gauge power wire
- Dimensions: 14.17 x 5.7 (W X H) Inches

ROCKVILLE

Troubleshooting

PROBLEM	SOLUTION
Unit will not power up	<ol style="list-style-type: none"> 1. Check your ground connection. 2. Check that the Remote Input Turn-On has at least 5V DC. 3. Check that there is battery power going to the +12V terminal. 4. Check all fuses, replace if necessary. 5. Make sure the protection LED is not on. If it is, shut off the amplifier briefly and then turn it back on.
Protection LED comes on when amplifier is powered up	<p>Turn down the volume control on the head unit to prevent overdriving. Check that there is good air flow around the amp.</p>
No Output	<ol style="list-style-type: none"> 1. Check that all fuses are OK. 2. Check that the unit is properly grounded. 3. Check that the Remote Input Turn-On has at least 5V DC. 4. Check that the input harness is properly connected. 5. Check that all inputs to the harness are properly connected. 6. Check remote control settings. 7. Check the input source's power settings.
Low Output	<ol style="list-style-type: none"> 1. Check that the input harness is properly connected. 2. Check that all inputs to the harness are properly connected. 3. Check remote control settings. 4. Check the input source's power settings.
High Hiss in the sound	<ol style="list-style-type: none"> 1. Check that all inputs to the harness are properly connected. 2. It is best to set the amplifier's gain control as low as possible. The best subjective signal-to-noise ratio is achieved in this manner. Try to set the head unit's volume level as high as possible without distortion.
Squealing noise is present	<p>Check for improperly grounded RCA interconnects.</p>
Distorted sound	<p>Check that the Input Gain control is set to match the signal level of the head unit.</p>
Engine noise: Static type	<ol style="list-style-type: none"> 1. Route your input cables away from the vehicle's wiring. 2. Use high quality RCA cables.
Engine noise: Alternator whine	<ol style="list-style-type: none"> 1. Check that the RCA grounds are not shorted to the vehicle chassis. 2. Check that the head unit is properly grounded.

ROCKVILLE

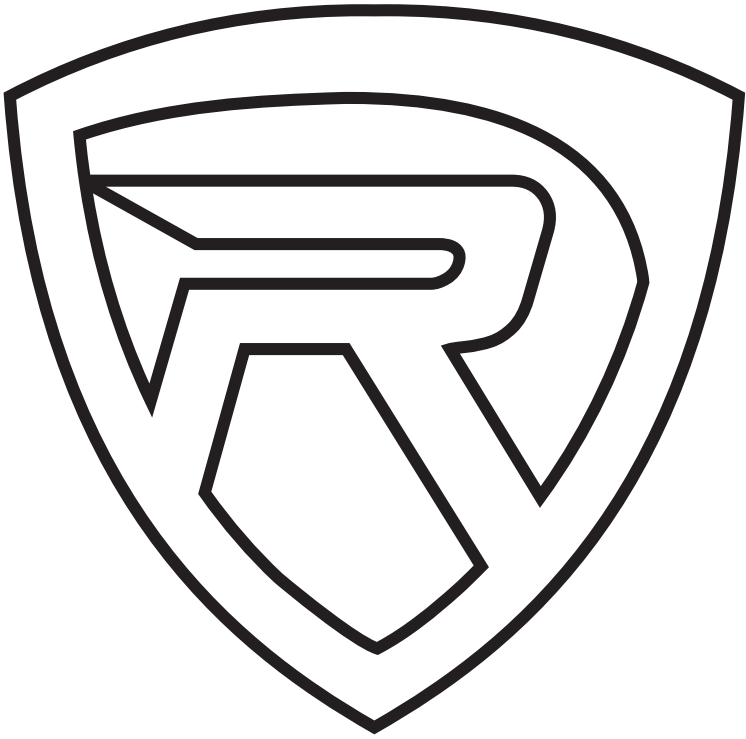

RockvilleAudio.com

© 2021 ROCKVILLE // Features and specifications are subject to change and or improvement without notice.