



**ROCKVILLE**



**IPS22**

Smart Phone/Tablet Mount

**ROCKVILLE**

ROCKVILLE

## Congratulations on your purchase of the Rockville IPS22 Smartphone/Tablet Mount.

The IPS22 supports most phones and tablets. It holds screens from 4.7" – 12.9". This means it will work with iPad, iPad mini, iPad pro, iPhone 6, iPhone 7, Samsung Galaxy, and most other tablets and phones. To check if your device is compatible, measure the screen on your device diagonally. If it is within 4.7" – 12.9" then you are good to go.

The IPS22 is fully adjustable. It can be oriented horizontally or vertically and it is mounted on a swivel so it can be tilted to any angle.

Please read this guide carefully for proper use of your Rockville IPS22 Smartphone/Tablet Mount. Should you need technical assistance please call our technical help line at 1-646-758-0144, Monday through Friday, 9am to 5pm EST.

## FEATURES/SPECIFICATIONS

- Rockville IPS22 Smartphone/Tablet Mount - Screws In To any Mic Stand or Boom Arm
- 5/8" threading will screw into any standard mic stand or boom arm
- Securely holds your tablet or phone in place without scratching it
- Multi-angle adjustment allows universal positioning of the tablet or smartphone
- Stand for iPad, iPhone and other tablets and phones from 4.7" to 12.9" screen sizes
- Fits any tablet with the width up to 9 inches - If the width of your tablet is 9 inches or under it fits perfectly
- Adjustable mounting bracket to fit many devices
- Tilts +5 degree and -5 degree for different angle viewing
- **Holder material** : ABS and rubber surface

# ROCKVILLE

## FUNCTIONS

### RETRACTED



### EXTENDED

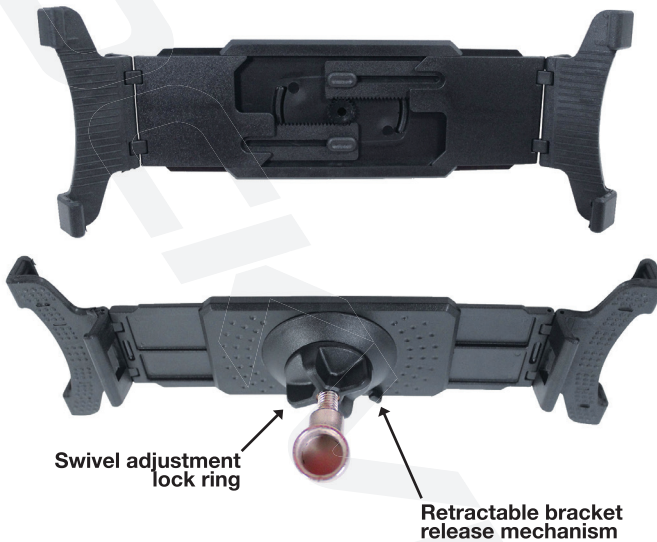

To ensure proper use of this product, please carefully read the following instructions:

### Assembly:

1. Screw the iPad holder to the any standard mic stand with 5/8" threading (fig. a).
2. Tighten the wing nut at the base of the holder (fig. b).

fig. a

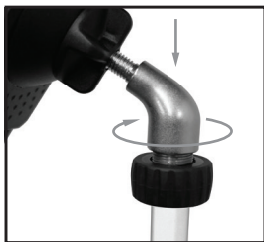
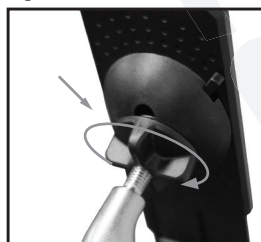

fig. b



## Attaching Tablet/Phone to Holder:

This IPS22 holder allows for adjustment of size, angle, and orientation. All this can be done without removing the iPad.

### To adjust angle/orientation:

1. With one hand on the holder, loosen the wing nut (fig. c).
2. Tilt the holder to the desired angle (fig. d).
3. Turn the holder to landscape or vertical position (fig. e)
4. Tighten wing nut. Remember do not over tighten.

fig. c

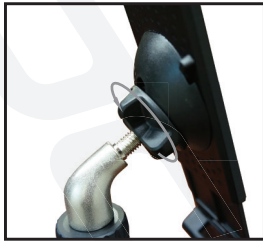

fig. d

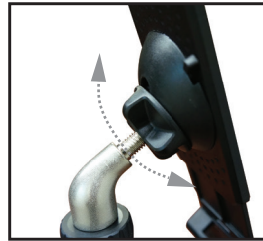
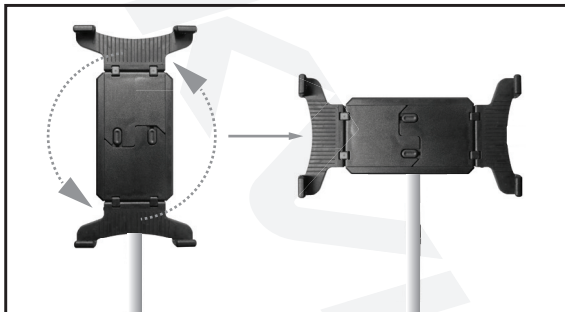
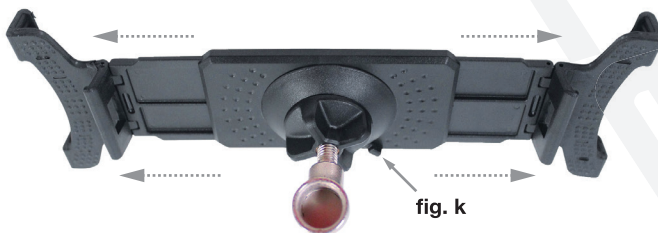

fig. e



### To adjust size:

1. Locate the release button on the rear of the holder just to the right of the wing nut (fig. k).
2. Push the button down while simultaneously pulling the top and bottom parts of the bracket. Pull slowly and carefully so as not to damage the mechanism. Once you release the button, the holder will remain in the current extended position.



**ROCKVILLE**

ROCKVILLE

ROCKWELL

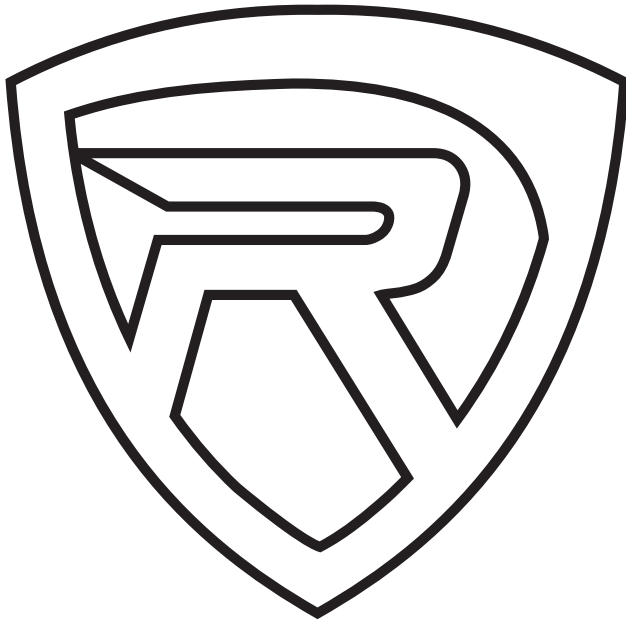

***ROCKVILLE***

**RockvilleAudio.com**

© 2018 ROCKVILLE // Features and specifications are subject to change and or improvement without notice.