

ROCKVILLE

KRYPTON S6 6-CHANNEL CLASS AB MARINE AMPLIFIER

OWNER'S MANUAL

WHO READS MANUALS?



Who reads manuals?

Scan the **QR code** or go to rockvillesupport.com/krypton-s6 to access how-to video(s), the owner's manual, and other important information you may need to get the most out of your item.

If you prefer written instructions, please read ahead!

With Rockville you get many options.

Missing items? If you ordered a bundle that includes more than one product and you are missing part of your bundle, then it just means your order shipped from two different warehouses. You will receive the remaining items very soon. If you have any concerns or inquiries, feel free to call our customer support center at 1-646-758-0144, Monday through Thursday, 9am to 10pm EST, and Fridays, 9am to 3pm EST.

ROCKVILLE

Introduction

Thank you for purchasing this Rockville KRYPTON S6 Class AB Marine Amplifier. Over the years, the technology used to create audio amplifiers has grown by leaps and bounds. Our competition is satisfied with just continuing to build the same units year after year without thought for improvement, but not Rockville. We consider it our mission to use our expertise in developing the latest technologies and to bring you the absolute best-sounding amplifiers on the market and of course at a reasonable price. You will be amazed at the quality and power that these new amps offer.

We have spared no expense in designing these amplifiers, creating the most rugged, reliable, powerful, and best-performing amplifiers. In fact, we are so sure of the quality, we backup every KRYPTON Series marine amplifier with a one-year warranty, which exemplifies our commitment to the end user (see enclosed warranty card for details.)

Please read this installation guide fully for proper use of your KRYPTON S6 marine amplifier. Read this entire guide fully before attempting your installation. Should you need assistance, please call our technical help line at 1-646-758-0144, Monday through Thursday, 9am to 10pm EST, and Fridays, 9am to 3pm EST.

IMPORTANT SAFETY INSTRUCTIONS



WARNING: BE AWARE! Use of this amplifier at extreme high volumes for extended periods of time may cause hearing loss and/or hearing damage. Your ability to hear necessary sounds will be impaired. Always keep your sound volume at reasonable levels when operating your vessel.

- When installing the amplifier, secure it tightly. An unmounted amplifier in your vessel can cause serious injury to passengers and damage if it is set in motion by an abrupt maneuver or sudden stop.
- To reduce risk of electric shock, never open the unit. There are no serviceable parts.
- Please ensure that the unit is situated in a properly ventilated area.

Installation

Installation Basics

Before you begin your installation, disconnect the NEGATIVE(-) terminal from your vessel's house battery. This safety precaution will avoid possible short circuits while wiring your amplifier. Rockville amplifiers operate on 12-volt negative ground systems only. It is recommended that you lay out your sound system design on paper first. This will help you during the installation so that you have a wiring flow chart and do not miss-wire any of your components.

Mounting The Amplifier

KRYPTON amplifiers feature four mounting feet that must be attached to the bottom of the amp via predrilled holes (see diagram below). Never install an amplifier in the engine compartment or on the firewall. Lay down the amplifier and mark the location of the mounting holes. It can be installed either horizontally or vertically. Remove the amplifier and drill pilot holes for the screws. Be sure to watch for your gas tank, gas lines, and electrical lines. Do not drill or mount any screws where they might penetrate the gas tank. Place the amplifier and secure it to the mounting surface using the supplied screws. Please be sure to leave breathing room around the amplifier heat sink so that it can efficiently dissipate the heat it produces.

- **AS CONNECTIONS CAN WORK LOOSE DUE TO VESSEL'S VIBRATIONS DURING NORMAL OPERATION, WE RECOMMEND PERIODICALLY TIGHTENING ALL POWER AND GROUND CONNECTIONS.**
- **DO NOT OVERTIGHTEN THE SCREWS.**

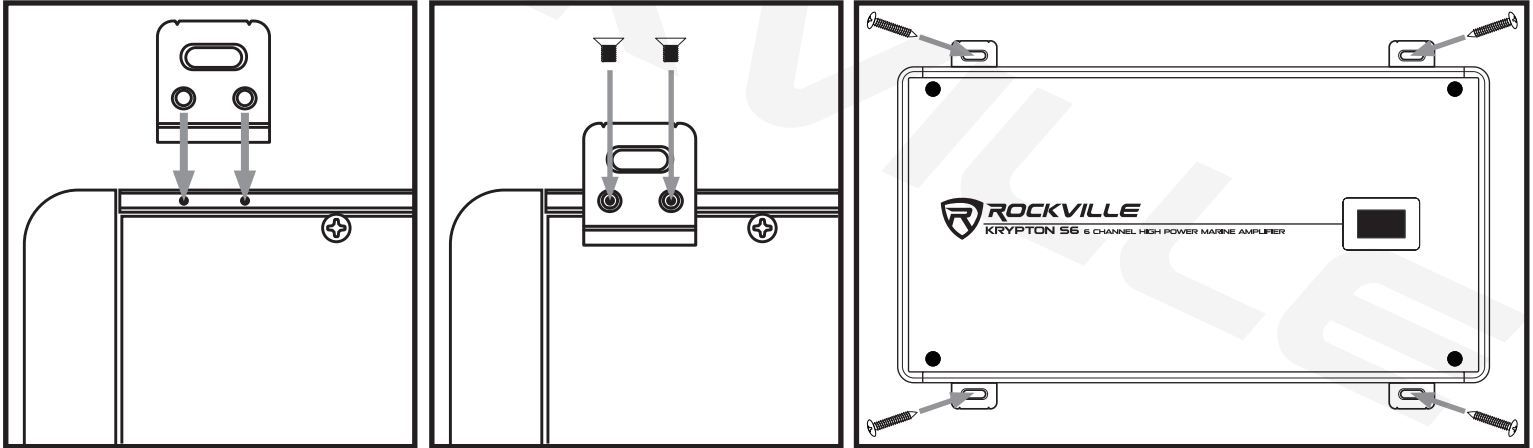

Wiring

1. Make sure to disconnect the **NEGATIVE (-)** terminal from your vessel's house battery.
2. Attach a 4-gauge or heavier wire to the amplifier screw terminal marked **GND**. Connect the other end to the house battery's **NEGATIVE (-)** terminal. The connection should be as close to the amp as possible (20 feet or less). For runs of 20 feet or more, you will need 2-gauge or heavier wire. If the black ground wire does not reach the battery, it can be connected to a metal part of the vessel. Make sure that there is no paint or other insulator blocking a good ground connection. When installing multiple amplifiers, mount them in close proximity so that they can all share the same ground point.
3. Connect the remote terminal to the head unit's remote output using 18-gauge or heavier wire. This connection is responsible for turning the amplifier on and off with the rest of the system. If there is no dedicated remote output, make this connection to the power antenna lead. Should your head unit not have *any* turn-on leads, you can wire the remote terminal to an accessory lead, which turns the amplifier on with your vessel's ignition.
4. Use 4-gauge or heavier wire to connect the screw terminal marked **+12V** to the house battery's **POSITIVE (+)** terminal. In order to protect the battery and electrical systems of your vessel, add an in-line fuse holder within 18" of the battery. This in-line fuse offers protection against damage from short circuits. The power wire should terminate in a large ring terminal connected directly to the **POSITIVE (+)** terminal. An optional second fuse can be installed closer to the amplifier for additional protection to the amplifier itself. If installing multiple amplifiers, install a distribution block near their location and, using a 0-gauge wire, connect the block to the in-line holder that is connected to the battery.
5. Insert fuse(s) into the in-line fuse holder(s) and check that all connections are properly secured.
6. Before powering up the system, set all the amplifier's level controls to minimum, the crossover/setting switches to the desired position, and the head unit's volume to 75%.

Never replace the supplied external fuses with ones of a larger value.

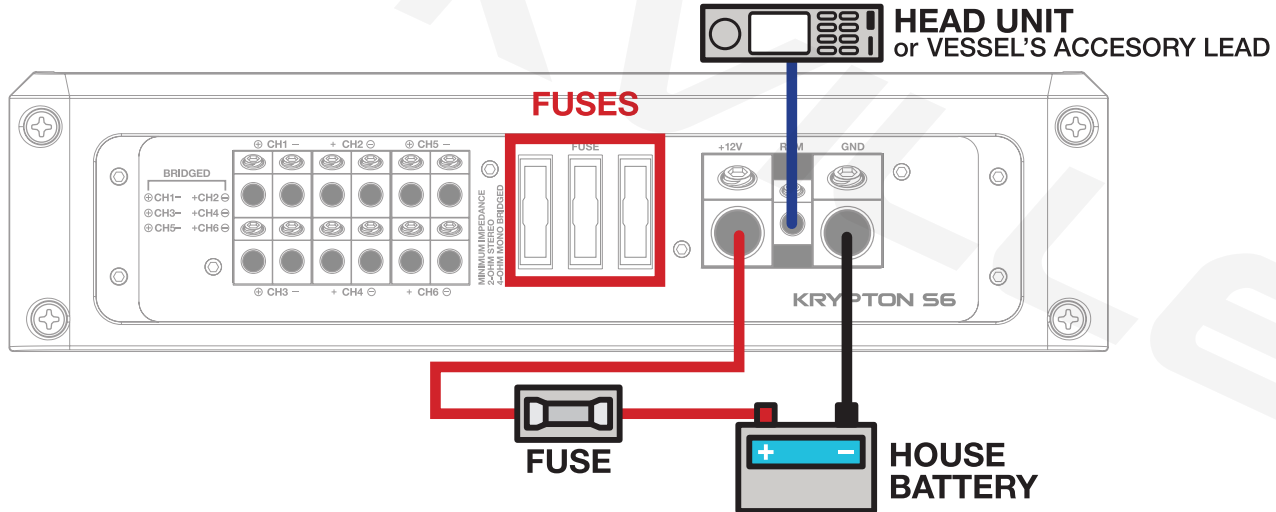

Wiring (continued)

PLEASE NOTE: FOR BEST PERFORMANCE BE SURE TO STRIP YOUR WIRE, AT MINIMUM, AS SHOWN IN THE DIAGRAMS.

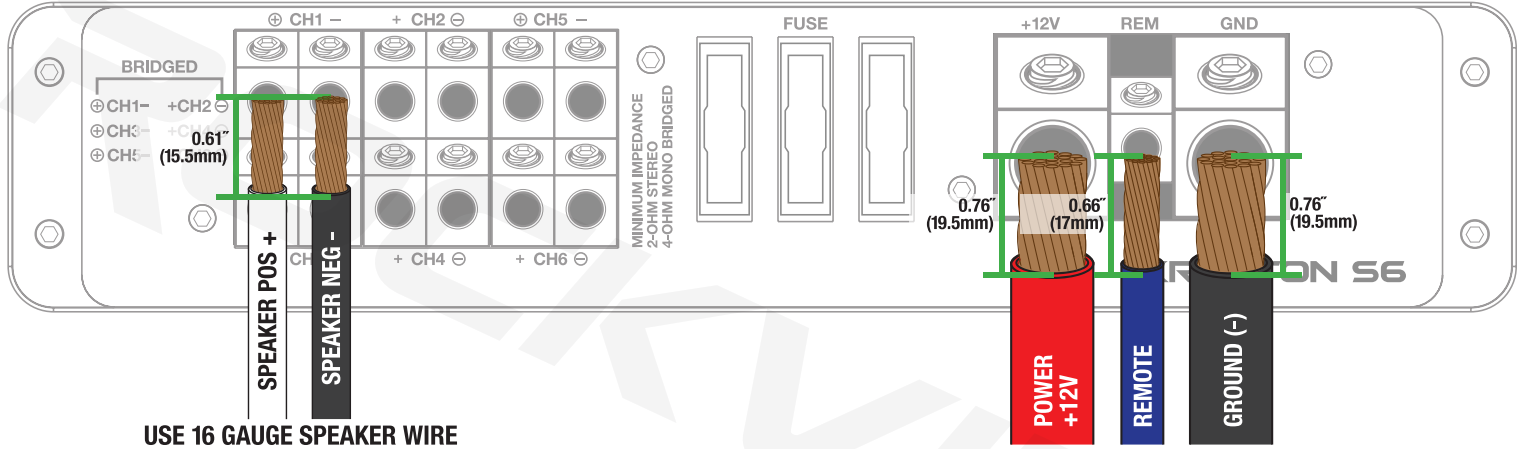

TERMINAL DIAMETER: POWER = Φ 0.33in (8.5mm), REM = Φ 0.15in (4mm), SPEAKER = Φ 0.15in (4mm)

TERMINAL DEPTH: POWER = 0.76in (19.5mm), REM = 0.66in (17mm), SPEAKER = 0.61in (15.5mm)

TIGHTEN SET SCREWS TO ENSURE WIRES ARE PROPERLY SECURED TO THE TERMINAL.

MAKE SURE THE WIRE IS PROPERLY SEATED.

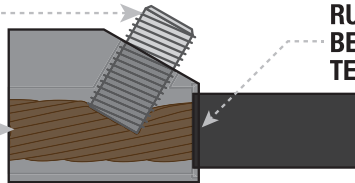

RUBBER SHEATHING SHOULD BE FLUSH AGAINST THE TERMINAL HOUSING.

Settings

Adjusting the System

1. Once the system is operational, set all crossover points to the approximate settings. In the case of a basic subwoofer system, set the Low Pass Filter (LPF) crossover at 100Hz or so. Set the Bass Equalizer (Channel 5 - 6 only) to 0dB and the Subsonic to between 25Hz and 35Hz. Turn the controls using a small flathead screwdriver. Do not apply any pressure while turning as this might break the control unit.
2. Set the Input Sensitivity using the control accessible on the side of the amplifier marked LEVEL (gain). Turn it counterclockwise to the MIN position. Adjust your head unit's volume gain to the maximum it can go before signal distorts or to the loudest gain, which is usually about 75% – 85% on most head units (you can look at the clip indicator LED or use an oscilloscope to see at what gain level your head unit distorts). When you begin to hear distortion, back down one notch. Now turn the LEVEL control on the amp clockwise until you hear distortion, then turn it counterclockwise by a notch or until the distortion is gone. The amp's input sensitivity is now set. It is helpful to have a second person to help you set the gain. When setting up a multi-amp system, set each amplifier's level controls separately. Start off with the bass amplifier, then adjust the highs amplifier's level control to match. Please note that the level control of any amplifier should not be mistaken for a volume control. It is a sophisticated device designed to match the output level of your source unit to the input level of the amplifier. Do not adjust the amplifier level to maximum unless your input level requires it. Your system can also be extremely sensitive to noise when the input level is set to maximum and does not match your input signal. These adjustments need to be made only once when first setting up the system.
3. Once you are satisfied with the level control settings, use any equalizer controls (Channel 5 - 6 only) only to adjust the system's tonal level for personal preference. Keep in mind that after equalizing you may have to go back and reset the amplifier's level controls.

If your unit has been professionally installed, please do not change the gain settings set by the installer, they are the professionals!

Using the Electronic Crossovers

The KRYPTON S6 marine amplifier features fully adjustable 12dB per octave low-pass (band pass), high-pass, and full-range electronic crossovers.

For Low-Pass systems, set the Channel 3 - 4 and Channel 5 - 6 CROSSOVER MODE switches to LPF (BP). Now the control marked LPF will control the low-pass frequencies from 40Hz – 4kHz. A frequent mistake made is setting the low-pass frequency too low, especially when using vented subwoofer enclosures. We recommend that for most installations you do not set the frequency knob lower than 80Hz.

When using the amplifier for coaxial or component speakers, you will want to set the CROSSOVER MODE switches to FULL (preferred) or HPF. The HPF control knob adjusts the high-pass frequencies between 15Hz – 4kHz.

Audio Preamp Input

All KRYPTON amplifiers feature RCA preamp inputs. Run RCA cables from your sound source to the amplifier inputs. We suggest you use high-quality, shielded RCA patch cords to help reduce and eliminate unwanted electrical noise to your system. Use good quality RCA interconnect cables. Cheaper cables usually have poor shielding that can cause interference pickup.

Be sure to run the RCA cables on the side of the vessel opposite to the side used to carry the power and ground leads of the amplifier.

Subsonic Filtering (Channels 3 - 4 and 5 - 6 only)

For subwoofer installations, you can set the amplifier's Subsonic knob(s) from the lowest setting to 30Hz. This will act as a SUBSONIC FILTER for all signals below that setting. This is especially useful for vented enclosures where the port tuning frequency falls below the subwoofer tuning frequency to protect against subwoofer unloading. Set the LPF to 120Hz and apply the bass EQ if needed.

Settings (continued)

Sealed Enclosures

Sealed boxes are tuned by enclosure volume: larger enclosures tune lower; smaller enclosures tune higher. Subsonic frequencies can cause damage to your woofer as they cause it to play below the enclosure's tuning, forcing it to the limits of its excursion and making it expend a lot of energy. To avoid damage to your woofer, set the Subsonic HPF to 25Hz – 35Hz.

Ported Enclosures

The enclosure's port should be tuned to a certain frequency so that the enclosure is capable of playing all frequencies above that tuning. The enclosure can play below that frequency, but only half and an octave before the cone starts to overextend. Hence, set the Subsonic HPF to half an octave below the tuned frequency.

Here is a simple formula to help you figure out the proper Subsonic HPF setting for your particular ported enclosure. Keep in mind that one octave up is double the frequency and one octave down is half the frequency:

1. Divide the tuning frequency of your port by 4.
2. Now subtract the quotient (answer) of Step1 from the port's tuning frequency. This is half an octave lower than your tuning frequency.

Example:

Port tuning frequency is 46Hz:

1. $46\text{Hz} \div 4 = 11.5\text{Hz}$ (half an octave lower)
2. $46\text{Hz} - 11.5\text{Hz} = 34.5\text{Hz}$ (Round up to 35Hz.) This is half an octave lower than 46Hz.

Please note: The subsonic filter is **NOT** a cutoff. It has a roll-off slope that will attenuate the frequency it is set to. Attenuation will increase as the frequencies get lower, meaning the power to the woofer decreases at the filtered frequencies, which reduces excursion and the potential for damage.

Subsonic filters have steep slopes such as 3rd or 4th order (18 or 24dB/Oct) so they can be set as close to your half-octave frequency as possible, or 25Hz – 35Hz sealed, without losing power in the surrounding frequencies.

Input Configurations

2-Channel Mode

If your head unit has one single pair of RCA outputs, connect them to the amplifier's channel 1 and 2 input jacks and set the Input Mode switch to 2CH. The amplifier's preamp circuitry will automatically mix all the channels and output will occur on all 6 channels. There will be left and right balance with constant subwoofer but no front to rear fader control.

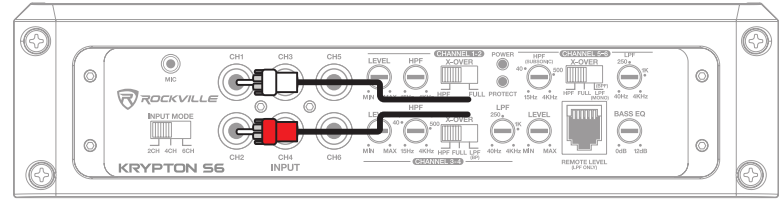

INPUT MODE SET TO 2 CHANNEL

4-Channel Mode

If your head unit has two pairs of RCA outputs, connect the Front Left and Front Right outputs to the amplifier's channel 1 and 2 input jacks. Connect the Rear Left and Rear Right outputs to the amplifier's channel 3 and 4 input jacks. Set the Input Mode switch to 4CH. The amplifier's preamp circuitry will automatically mix all the channels and output will occur on all 6 channels. There will be left and right balance and front to rear fader with constant subwoofer.

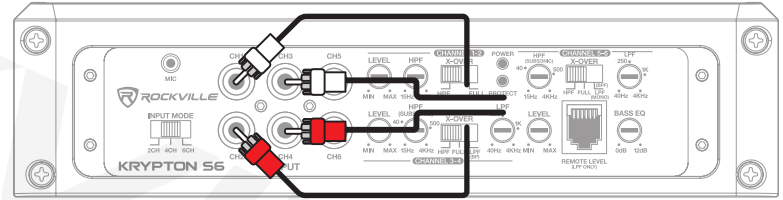

INPUT MODE SET TO 4 CHANNEL

6-Channel Mode

If your head unit has three pairs of RCA outputs, connect the Front Left and Front Right outputs to the amplifier's channel 1 and 2 input jacks. Connect the Rear Left and Rear Right outputs to the amplifier's channel 3 and 4 input jacks. Subwoofer outputs should be connected to channel 5 and 6. If your head unit has only a single subwoofer output, use a Y adaptor to feed both channel 5 and 6 inputs. Set the Input Mode switch to 6CH. The amplifier's preamp circuitry will automatically mix all the channels and output will occur on all 6 channels. There will be left and light balance and front to rear fader with independent subwoofer.

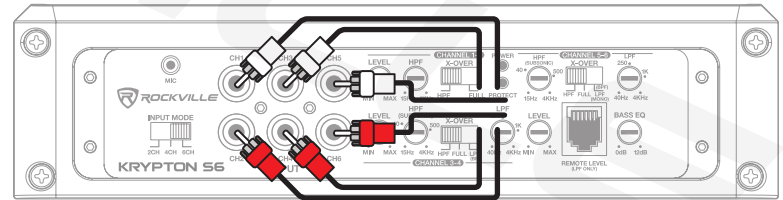

INPUT MODE SET TO 6 CHANNEL

Output Configurations

6-Channel Mode: Component speakers and dual subs

Channels 1, 2, 3 and 4 should be wired to speakers with no lower than a 2-ohm load per channel in stereo. Channels 5 and 6 should be wired to subwoofers with a minimum impedance of 2 ohms. Set the Crossover Mode Switches of channels 1-2 and channels 3-4 to Full Range. Set the channel 5-6 crossover mode switch to LPF.

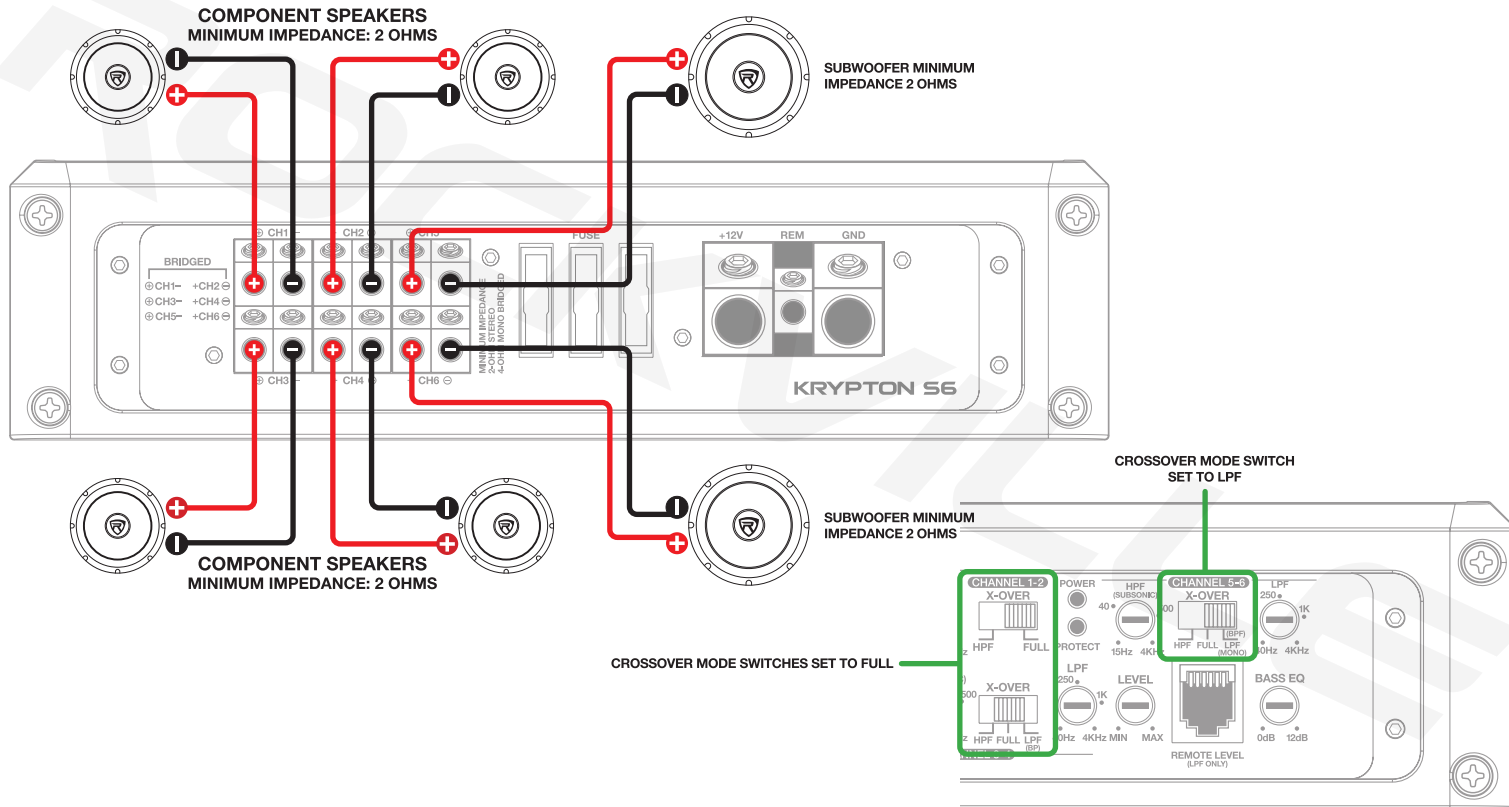

5-Channel Mode: Component speakers and single sub

Channels 1, 2, 3 and 4 should be wired to speakers with no lower than a 2-ohm load per channel in stereo. Channels 5 and 6 should be bridged as per the diagram, wiring a 4-ohm minimum impedance woofer to Channel 5's positive (+) terminal and Channel 6's negative (-) terminal. Set the Crossover Mode Switches of channels 1-2 and channels 3-4 to Full Range. Set the channel 5-6 crossover mode switch to LPF

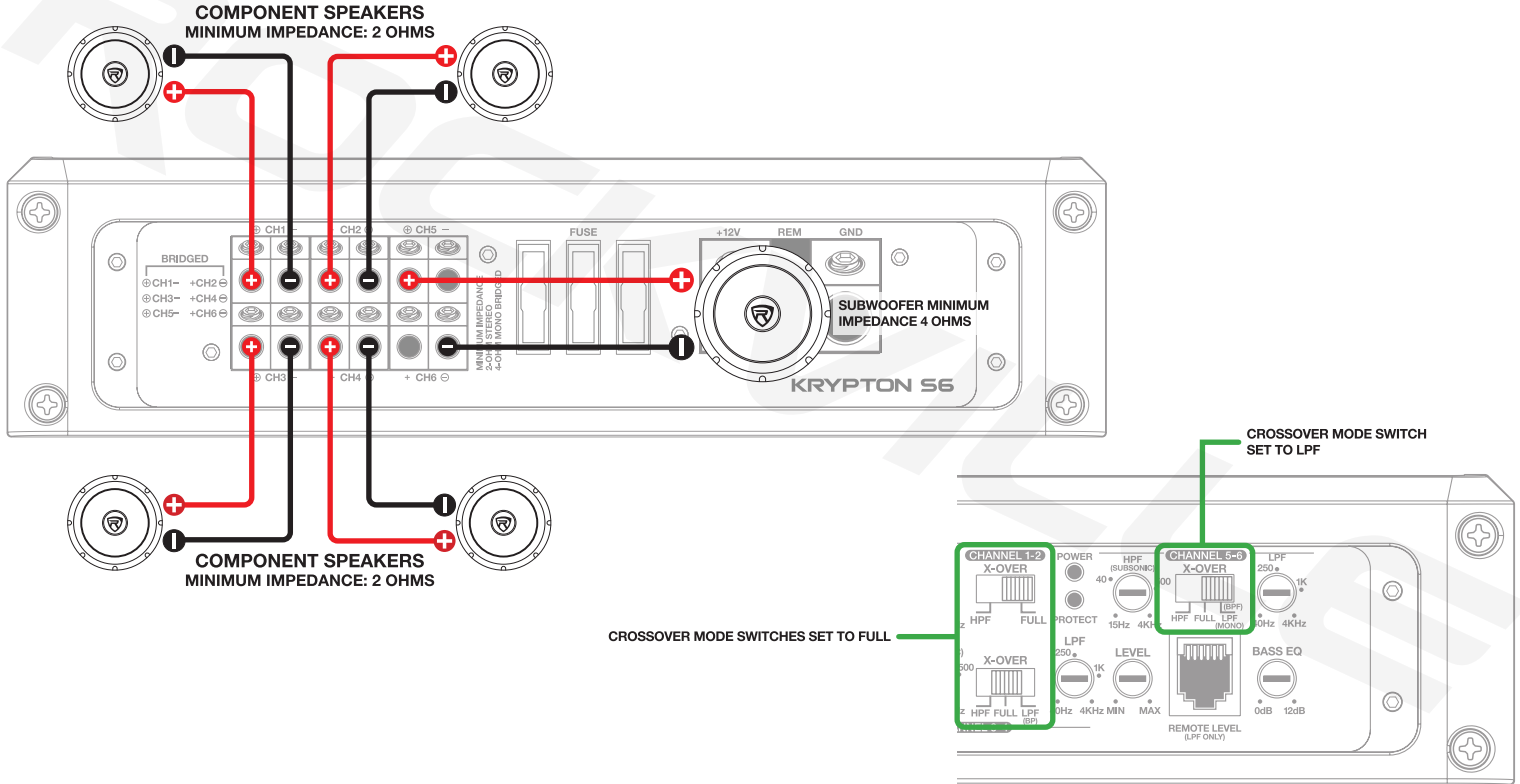

Output Configurations (continued)

5-Channel Mode w/Two Subwoofers

Channels 1 and 2 and Channels 3 and 4 should be wired to speakers with no lower than 2-ohm load per channel in stereo. Channels 5 and 6 should be bridged, as per the diagram, to two single voice coil 2-ohm woofers in series which will result in a final load of 4 ohms at the amp. Set the Crossover Mode Switches of Channels 1 and 2 and Channels 3 and 4 to Full Range, while Channels 5 and 6 should be set to LPF.

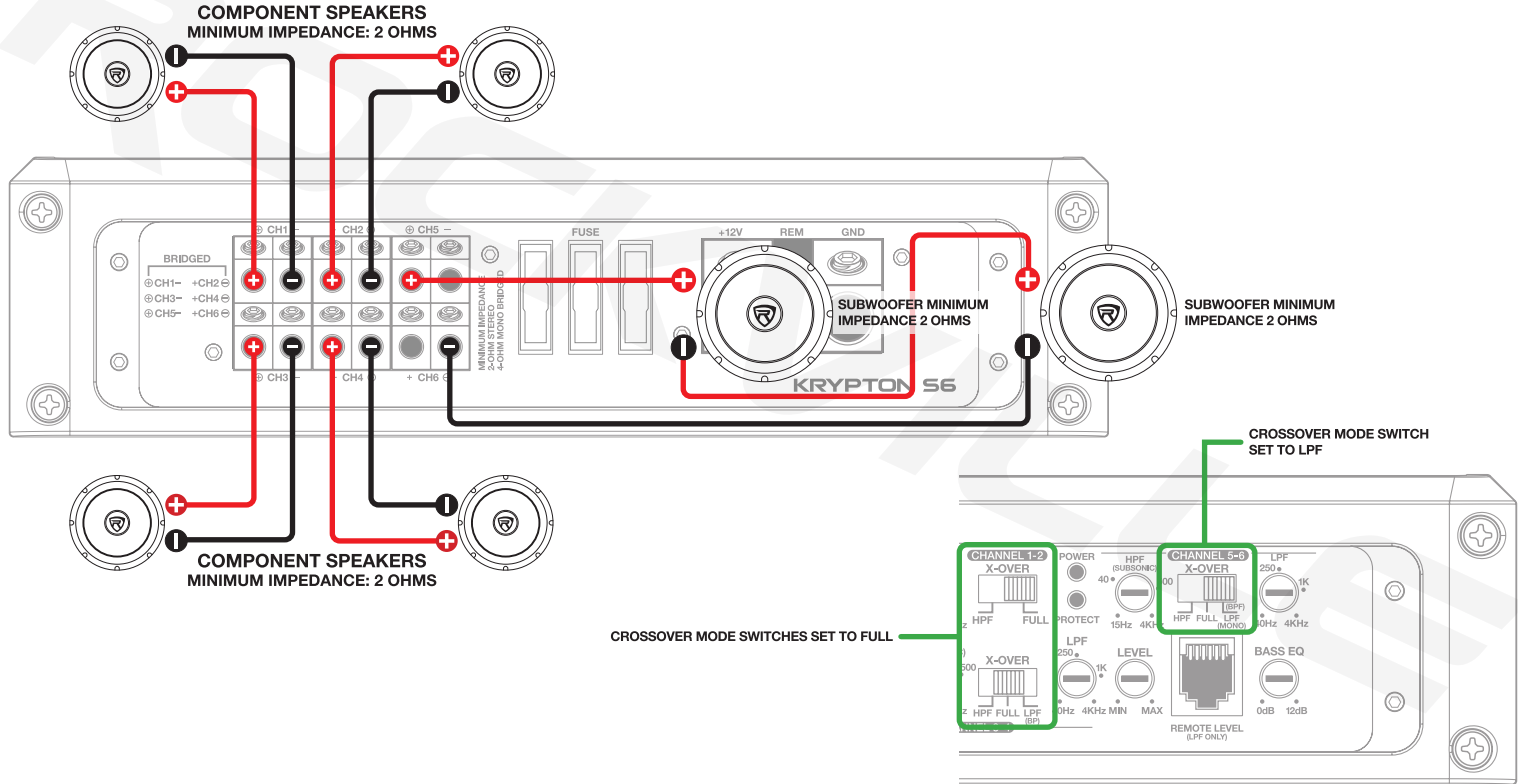

Public Address System

This amp features a marine public address system with microphone and talk-over functionality. Simply connect the included microphone to the 3.5mm jack marked MIC and you are ready to go. When the microphone is keyed (a), music will fade to the background. When microphone is unkeyed, music slowly fades back in. Adjust the microphone's volume using the adjustment knob (b).

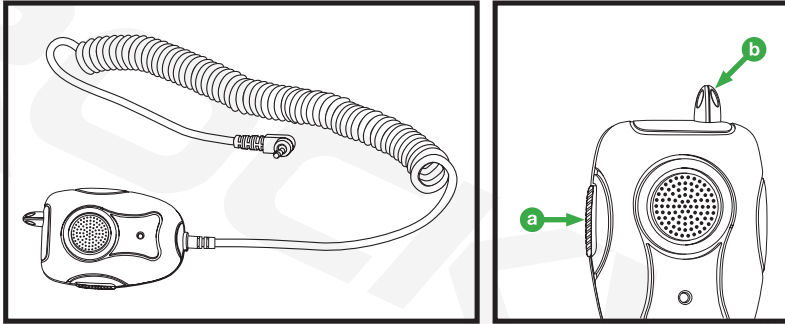

CONNECT MICROPHONE HERE

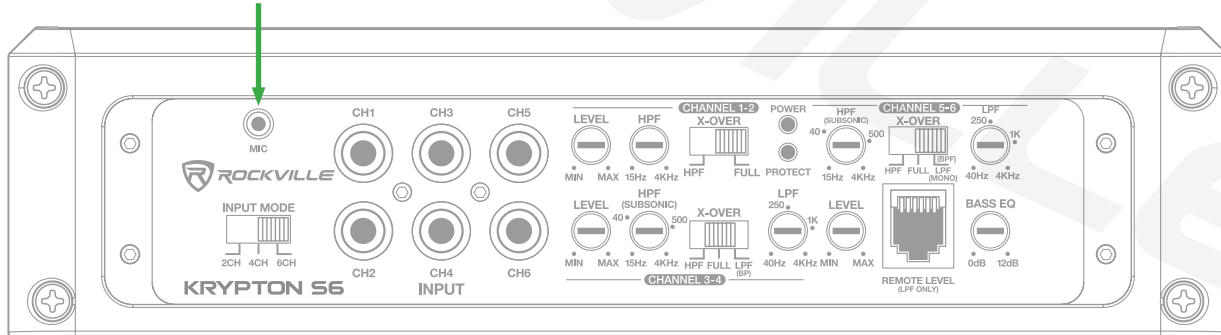

Features

Bass Equalization Circuitry

A narrow “Q” peaking equalization circuit is included in the amplifier. The equalization system is preset at 45Hz. The equalizer control allows you to add up to 12dB of bass boost. Utilize the bass equalizer to tailor your bass response to your system’s needs. Make sure your speakers can handle the extra power output! It would be foolish to add 12dB of gain to low excursion 8” and 10” subwoofers or mid ranges and tweeters. It’s a sure way to blow your speakers.

Audio Output Section

The audio output section of this KRYPTON Marine amp features high-speed MOSFET power supplies.

Power and Protection Circuitry

This amplifier features our unique IC-controlled protection circuitry. This sophisticated circuit constantly monitors the heat sink internal temperature and various voltages, adjusting the amp automatically and protecting it from dangerous conditions. This models feature two LEDs located on the side of the amplifier that provide indication of the amplifier’s status. The POWER LED will light when the amplifier is receiving proper power, ground, and remote voltages, and the IC monitoring sequence indicates the amp is functional. In case the amplifier encounters a diagnostic condition as listed below, the PROTECT LED will light indicating a diagnostic condition. When a diagnostic condition is sensed, the amplifier will then turn into self-preservation mode and if the cause of the diagnostic condition is not corrected will eventually shut down. There are certain critical diagnostic conditions that will turn the amplifier off immediately.

Thermal Protection: When the amplifier reaches an unsafe operating temperature of 80 degrees Celsius, the amplifier will turn off. Once the amplifier cools down to a safe temperature, it will automatically turn on again. If you live in a hot climate, we suggest installing additional cooling fans to exhaust the hot air which can build up in the installation location. This will help keep the ambient temperature in the installation location as low as possible so that your amps work flawlessly and without any musical interruption.

Speaker Short Circuit Protection: Should your speakers short circuit due to voice coil burn out, or should the amplifier sense an impedance too low to handle, the protection LED will light, indicating a diagnostic condition. Turn off your system, disconnect one speaker at a time, and try to determine which speaker might be faulty. Correct the condition and restart the amplifier. You must reset the amplifier by turning it OFF and then ON again by the Remote power connection after correcting a diagnostic condition. (Turn your radio off and then on again.)

Input Overload Protection: This circuit will either shut down the amplifier completely or make the amplifier spurt on and off indicating that it is in a diagnostic condition. Turn the system off and reduce the gain on the amplifier or volume from your head unit. This should result in a corrected condition.

DC Offset Protection: Should any DC voltage try to enter the amplifier via the speaker terminals it will cause the amplifier to shut down and not operate until this condition is remedied. This circuit will also protect damaging high DC voltages from reaching your speakers should your amplifier ever malfunction.

PLEASE NOTE: You must reset the amplifier by turning it OFF and then ON again after correcting a diagnostic condition (turn your radio off and then on again). If the amplifier stays in protection after a reset, it is most likely faulty.

Mute Circuit

This is an anti-thump, mute and delay circuit that eliminates irritating, speaker damaging turn-on and turn-off transients normally experienced with less expensive amplifiers.

Bass Remote

The dash-mounted bass remote allows you to control the amplifier’s bass level from the comfort of the driver’s seat. It features a power LED which indicates the unit is receiving power and operating nominally.

Battery Voltage

KRYPTON Series Marine amplifiers feature a convenient LED readout which displays the current voltage input while the amp is in use. These amps will go into protect mode when the voltage goes below 10 volts or above 16 volts.

Additional Features

- High-Speed MOSFET Power Supply
- Tertiary Supplies Circuitry
- Studio-Grade Bipolar Output Stage Transistors
- 4 Gauge power and ground terminals
- 10 Gauge speaker wire terminals
- All channels on the amp have crossovers so they can each be used for subs or full range speakers or tweeters or midrange speakers
- All channels on the amplifier are bridgeable
- Fully Adjustable 12dB / Octave Crossover with Differential Circuitry
- Fully Adjustable 12dB Bass Equalizer
- Adjustable Input Level Control
- Mute and Delay Soft Start System
- 2CH/4CH/6CH Input Mode Switch
- Status Mode LED Indicator
- Full IC-Controlled Protection Circuitry
- 8 Volt Preamp Circuitry
- Under Voltage Protection at 10V
- Over Voltage Protection at 16V
- Remote dashboard subwoofer control
- Microphone Input (PA Microphone included)
- Painted Conformal Coating PCB Board (Uses 2577 Waterproof Glue)
- Rustproof Aluminum heat sink with white powder finish
- Stainless steel end panels are rustproof
- All screws and mounting hardware are stainless steel and rustproof
- Bottom panel is aluminum and rustproof

Specifications

- Dyno Certified RMS Power Output
 - 2 Ohm: 110 Watts x 6 Channels <1% THD+N
 - 4 Ohm: 75 Watts x 6 Channels <1% THD+N
 - 4 Ohm Bridged: 220 Watts x 3 Channels <1% THD+N
- Peak Power Output
 - 2 Ohm: 440 Watts x 6 Channels
 - 4 Ohm: 300 Watts x 6 Channels
 - 4 Ohm Bridged: 880 Watts x 3 Channels
- Subsonic Filter (HPF, Channels 3-4 and 5-6 only): 15Hz – 4KHz
- Low Pass Filter (Channels 3-4 and 5-6 only): 40Hz – 4kHz
- High Pass Filter (Channels 1-2): 15Hz – 4kHz
- Minimum THD at Rated Power: <0.05%
- S/N Ratio: >90dB
- Frequency Response: 10Hz – 50kHz
- Damping Factor: >85 @ 100Hz
- 3 x 30 Amp ATC Fuse
- Dimensions: (W x H x L) 8.66" x 2.2" x 18.3"

Woofer Wiring Guide

SVC Configurations

The minimum impedance load for a single S6 amp is 2-ohm stereo and 4-ohm mono bridged. Lower impedance loads will cause overheating and may damage the amp.

Do not mix different impedance speakers in series and/or parallel combinations, as unequal power sharing and acoustic outputs will result.

ONE 2Ω SVC WOOFER = 2Ω LOAD

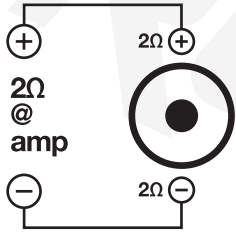

TWO 2Ω SVC WOOFERS = 4Ω LOAD

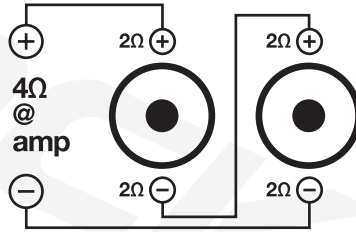

FOUR 4Ω SVC WOOFERS = 4Ω LOAD

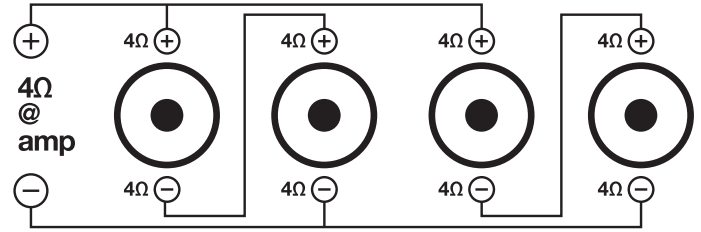

ONE 4Ω SVC WOOFER = 4Ω LOAD

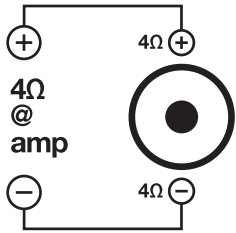

TWO 4Ω SVC WOOFERS = 2Ω LOAD

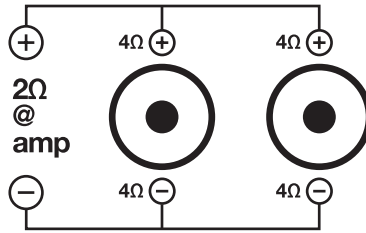

FOUR 8Ω SVC WOOFERS = 2Ω LOAD

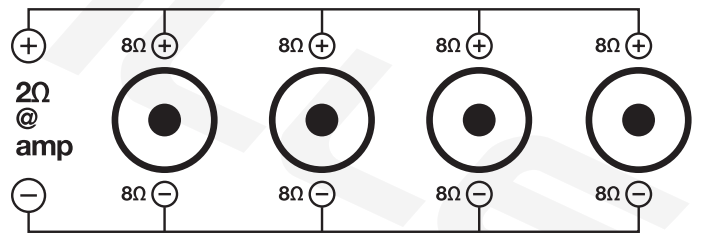

DVC Configurations

ONE 2Ω DVC WOOFER = 4Ω LOAD

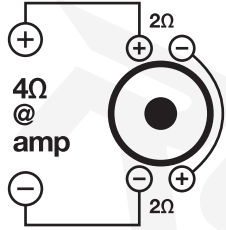

TWO 2Ω DVC WOOFERS = 2Ω LOAD

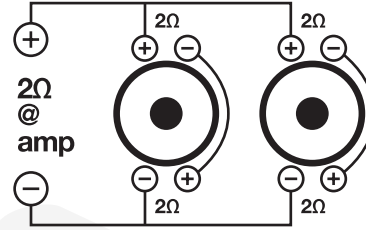

THREE 2Ω DVC WOOFERS = 3Ω LOAD

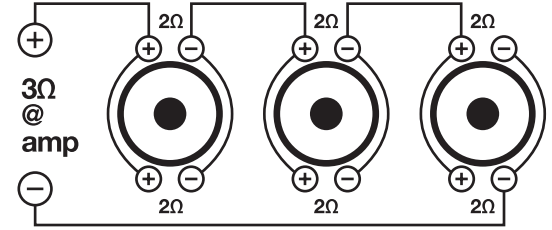

ONE 4Ω DVC WOOFER = 2Ω LOAD

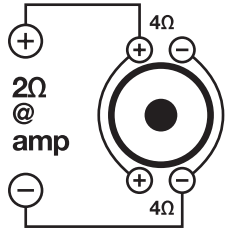

TWO 4Ω DVC WOOFERS = 4Ω LOAD

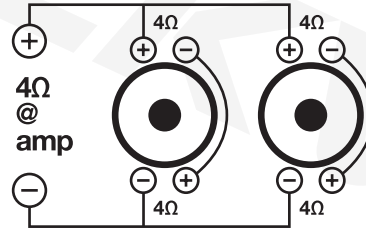

THREE 4Ω DVC WOOFERS = 2.67Ω LOAD

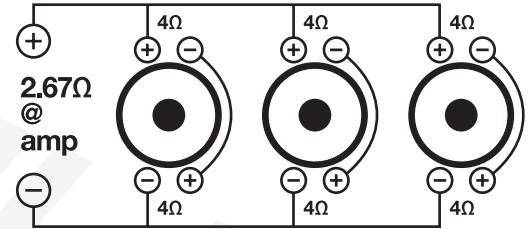

FOUR 4Ω DVC WOOFERS = 2Ω LOAD

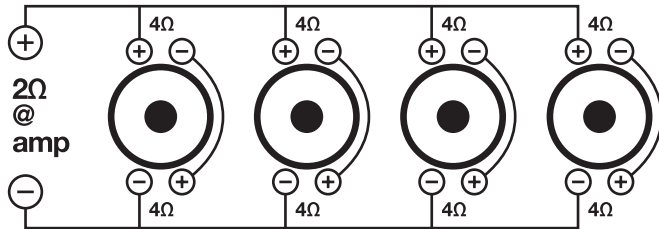

FOUR 2Ω DVC WOOFERS = 4Ω LOAD

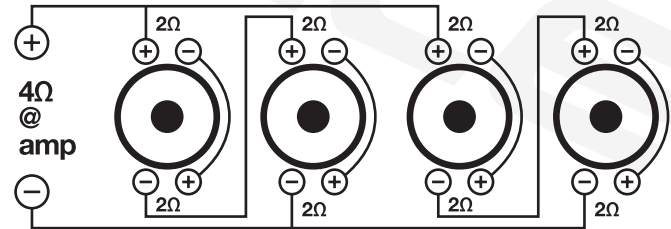

ROCKVILLE

Troubleshooting

PROBLEM	CAUSE/SOLUTION
Amp goes into protect mode	<ol style="list-style-type: none">1. Short circuit protection - Caused by the power or ground wire not being fastened tightly. Disconnect the speakers from the amp. If the amp is still in protect mode, you now know the issue is somewhere with the power, ground, or remote wire. You should check and make sure the ground is tight. You should check the power wire terminals. Make sure the positive is going to the positive, and the negative is going to the negative. If all this is secure, you can use a multimeter or the LED display on the top of the amp and make sure you are getting 12 – 14.4 volts coming from your power wire. If this is all checking out properly, then you should check that the remote wire is properly connected to the remote wire on your receiver. Many times people mistakenly connect it to the antenna wire instead. If this is correct, you should also use a multimeter and make sure your remote wire is getting 5 volts.2. Thermal protection - This happens when the amplifier overheats. Check that your subwoofers or speakers are compatible with your amp and that they are wired correctly.3. Blown speaker - To check for a blown speaker, disconnect all the speakers from the amplifier. If the amp goes out of protect mode, then the problem is indeed a blown speaker. Find which speaker is blown and replace it.4. Wrong speaker impedance - Replace the speaker(s) with one of the proper impedance.5. Speaker wires touching - If the positive and negative speaker wires that run from your speakers to your amplifier touch each other either by the speaker terminals or by the amplifier terminals, the amp will go into protect mode. Check all speaker connections to ensure that the wires are not touching.6. Reverse polarity protection - Reverse polarity means the positive and negative power wires are backward. Connect the speaker wires to the correct terminals.7. Power wire gauge - If your power and ground wire are not thick enough, the amp will go into protect mode to protect itself from unsafe signals. Be sure to use the proper gauge wires.8. RCA cables - RCA patch cables that are grounded out or otherwise faulty can also cause the protect light to come on. To check this, you can simply hook up a set of known good RCA cables to your head unit and amp. If that causes the light to turn off, replacing the RCA cables will fix the problem.

PROBLEM	CAUSE/SOLUTION
Amp won't power on	<ol style="list-style-type: none"> 1. The external fuse is not properly secured to the power wire or is not making proper contact to the wire. Ensure the fuse is properly seated and making contact. 2. Your external fuse (inside the fuse holder) is blown. Replace the fuse. Never replace the supplied external fuse with one of a larger value. 3. Check the ground wire. Make sure the connection is 100% secure and tight. 4. Power wire is not connected properly to the ring terminal or it has acid corrosion on it. Check the connection to the ring terminal and use a wire brush to clean any corrosion off the ring. 5. Check the power wire. Make sure the positive is wired to the positive, and the negative is going to the negative. Make sure the power wire is secure. 6. Check the remote turn-on wire. Make sure that this wire is connected securely to the amplifier on one end, and make sure the other end is connected to the remote turn-on of the receiver. A common error we see is the remote turn-on gets connected to the antenna wire instead of the remote turn-on wire of the head unit. Please note the remote turn-on wire is a required wire. The amp will not work if this is not connected. It is also possible the remote terminal is loose and fell out. 7. Power wire is connected to the ground terminal of the amplifier. Connect the power wire to the +12V terminal of the amp. 8. Power or ground wire became loose. Check all connections and make sure they are tight.
Power but no sound	<ol style="list-style-type: none"> 1. Check if any protection lights are on. If protection lights are on, please refer to the "Power and Protection Circuitry" section on page 14 and the "Amp goes into protect mode" section on page 19. 2. Check the RCA cable that is going from the amplifier to the receiver. We recommend having a spare RCA cable to test with. Many times RCA cables go bad since they are thin cables. You can also test your RCA signal using a multimeter.

PROBLEM	CAUSE/SOLUTION
Power but no sound	<p>3. The next thing to check is the speaker wire that is going from the amp to the speakers. If the amplifier is in bridged mode, then be sure you connected the speaker wire to the proper terminals.</p> <p>4. Check your gain on the amp. If it is on 0, then turn it up slowly.</p> <p>5. Check the RCA cable that is plugged into your receiver. Make sure you plugged the amplifier into the pre-amp output that is red and white. In many cases we have seen customers plug the RCA into the RCA video of their receiver, which is yellow. If this is the case, just plug the RCA into the proper connections and your problem will be solved.</p> <p>6. There is a setting on your receiver that can disable your RCA outputs. The setting is under fader/balance control. On your receiver navigate to fader/balance and find the setting, then make sure you enable front, rear, and sub preamp outputs. Sometimes the head unit will allow you only to enable front and rear, which would cause the amp to have no sound.</p> <p>7. Speaker wire is not making a good contact on the speaker output of the amp or on the speaker terminal. You need to make sure the speaker wire is securely tightened into the speaker terminal and the amplifier terminal.</p> <p>8. A pinched or cut speaker wire that is now not running a signal. Speaker wire is very thin and can rip or tear easily. If you have spare speaker wire, then you can test this issue with new speaker wire and see if that solves your issue. You can also visually inspect your current speaker wire.</p> <p>9. Make sure the positive and negative speaker wire are running to the positive and negative speaker terminal of the amp. If they are reversed, then the speaker will play no sound or very little sound.</p>
Amp is clipping	<p>1. Speakers/subs are too powerful for the amplifier you are using. Check the compatibility of your speakers/subs. Replace incompatible speakers/subs with compatible ones.</p> <p>2. If the speakers/subs are wired at a lower impedance (ohms) than the amp is supposed to be playing, this can cause the amp to clip. Wire the speakers/subs at the proper impedance.</p>

PROBLEM	CAUSE/SOLUTION
Amp is clipping	<p>3. If the gain setting is too high, this can cause the amp to clip. The proper way to set your gain is to turn your receiver volume to 75% of the max, and then slowly turn your gain up. The second you hear any slight distortion, turn it down one notch and leave it at that setting. Amps are not meant to be played with the gain up to the max. If this is the case, lower your gain slowly until you hear the amplifier stop clipping.</p> <p>4. A poor ground cable connection can cause your amp to clip because improper power is getting to the amp. Check your ground connection and make sure that the cable is securely tightened.</p> <p>5. A very common cause of amplifier clipping is power and ground wire that is too thin of a gauge size for the amplifier. Determine the proper wire gauge necessary and replace existing wires.</p> <p>6. If using multiple devices that all have a volume control (such as an equalizer or processor, receiver, and the amp), then you would need to lower one or two of those devices to stop the amp from clipping.</p>
Distortion, background noise, crackling, or hissing in the speakers	<p>1. First check to see how your wires are run. If your RCA cables and speaker wire are run alongside your power cables, they will pick up feedback. If this is the case, you will need to run the RCA cable on the other side separate from your power cable.</p> <p>2. A poor ground cable connection can cause your amp to clip because improper power is getting to the amp. Check your ground connection and make sure that the cable is securely tightened.</p> <p>3. Engine noise – you will know it is engine noise if every time you rev your engine the noise gets louder. You can install a ground loop isolator on the receiver's power lead to cut down on signal pollution. Most often, however, engine noise comes from a loose or intermittent ground connection. Make sure your ground connection is tight and that you are using the proper gauge cable.</p> <p>4. If your gain on your amp is set to the max and your receiver has a high preamp voltage, it will cause some unwanted noise. To properly set your gain, play a CD or other music. Now put the receiver volume to 75% – 80% of the max. Then slowly turn the gain of the amp to a setting where you do not hear a loud hiss. A low hiss is acceptable, as with music playing you will never hear it. Please note the amp gain is not a volume control. It is meant to be matched to the preamp voltage of a head unit. It is important to properly set your gain when you buy a new amp.</p>

PROBLEM	CAUSE/SOLUTION
Distortion, background noise, crackling, or hissing in the speakers	<p>5. Noise can be picked up due to bad RCA cables. Specially the super cheap ones. We recommend doing a test with different RCA cables. Replace the RCA cables if needed.</p> <p>6. Low-quality speaker wires will also cause noise. We recommend you buy high-quality insulated speaker wire made for marine applications.</p>
Sound is too low	<p>1. This can be caused by wiring at too high of an impedance (ohms) and the amp puts out low power, at 4 or 8 ohms for example. To resolve this, you will have to properly wire your speakers/subs to the amplifier.</p> <p>2. Check the gain level on the amp. You may need to turn it up.</p> <p>3. Power and ground wire that are too thin of a gauge size for the amplifier may cause low sound. Determine the proper wire gauge necessary and replace existing wires.</p> <p>4. Make sure your positive and negative speaker wires are not reversed, as this would cause the sub to move but not make much noise.</p> <p>5. Check your crossover setting on your amplifier. You may need to filter out more high frequencies, which your sub is not meant to play. So make sure it's on low pass mode and then you also should try lowering the frequency of that low pass crossover and see if that helps.</p> <p>6. On your receiver it is very common to have a volume level control for the preamp outputs (separate from your master volume control). To fix this, you can navigate to the audio settings, and search for subwoofer level controls, as well as front and rear preamp output controls. Crank up the level on this setting and you will be back in business.</p> <p>7. Amplifier may not be powerful enough. If this is the case, we recommend upgrading to a more powerful amplifier.</p>
Amp keeps blowing fuses	<p>Main Fuse - If you determine that your main fuse is blowing, then you'll want to pay attention to when it blows. Try inserting a good, properly rated fuse with your head unit—and amplifier—turned off. If the fuse blows immediately, when everything is off, then you're probably dealing with some kind of short in the power cable between the main fuse and the distribution block, or between the main fuse and the amplifier if there is no distribution block in the system.</p>

PROBLEM	CAUSE/SOLUTION
Amp keeps blowing fuses	<p>Distribution Block Amp Fuse - If both sides of the main fuse have power, and one side of the distribution block has power, but the other side of that fuse is dead, then you're either dealing with a shorted power wire or an internal amplifier fault. There are a few ways to determine which one is the culprit, depending on how your amp is installed and where the wires are routed.</p> <ol style="list-style-type: none"> 1. Check if you can see power wire that connects the distribution block to your amp. In an ideal situation, you'll be able to see the entire length of the wire. If that isn't possible, then the next best thing is to just disconnect the power wire from your amp, make sure that the loose end isn't in contact with ground, and check whether the fuse still blows. If it does, then the problem is in the power wire, and replacing it will almost certainly fix your problem. Of course, you'll have to take care when routing the new wire so that it doesn't end up shorting out as well. If the fuse doesn't blow with the power wire disconnected from your amp, then you have an internal amplifier problem. <p>Internal Amplifier Fuse - If the fuse blows when the amp is turned up, then you likely have subwoofers or speakers that are either incompatible or that are wired at too low of an impedance. Rewire to achieve proper impedance, or replace the subwoofers or speakers with compatible ones. Check and make sure the power and ground wires did not get crossed. Also, check and make sure your speaker wires are not crossed.</p>
Amp gets very hot	<ol style="list-style-type: none"> 1. The main reason amps overheat is if the impedance they are running at is very low, or if the subwoofer or speaker requires more power than the amp can give it. Also if the wiring cannot give the proper current fast enough, it can cause the amp to get hot as well. Make sure the amp is running at the proper impedance, or use subwoofers or speakers that are compatible with the amp. Make sure the wiring is correct and you are using the proper wires for your system. 2. A poor ground cable connection can cause your amp to get very hot. Check your ground connection and make sure that the cable is securely tightened. 3. Check the location where your amp is mounted. Make sure it is in a spot where it will receive proper ventilation.

PROBLEM	CAUSE/SOLUTION
<p>Amp or powered sub does not turn off when you turn off the vessel</p>	<ol style="list-style-type: none"> 1. This situation happens when you connect the remote turn-on wire to a constant 12V power wire (often this is a yellow wire) instead of to the remote turn-on wire of your receiver's wire harness. Pull out your receiver and plug the amplifier's remote turn-on wire into the proper remote turn-on terminal of your receiver's wire harness. 2. In a rare situation, the remote turn-on wire input is touching the power wire, which can also cause this same issue. If this is what is happening, then simply take the remote turn-on wire out of the amplifier terminal and carefully put it back in so that it is not touching the power wire.
<p>One channel on the amp isn't working</p>	<ol style="list-style-type: none"> 1. Check the RCA cable that is going from the amplifier to the receiver. We recommend having a spare RCA cable to test with. Many times RCA cables go bad since they are thin cables. You can also test your RCA signal using a multimeter. 2. Check the RCA cable that is plugged into your receiver. Make sure you plugged the amplifier into the pre-amp output that is red and white. In many cases we have seen customers plug the RCA into the RCA video of their receiver, which is yellow. If this is the case, just plug the RCA into the proper connections and your problem will be solved. 3. There is a setting on your receiver that can disable your RCA outputs. The setting is under fader/balance control. On your receiver navigate to fader/balance and find the setting, then make sure you enable front, rear, and sub preamp outputs. Sometimes the head unit will allow you only to enable front and rear, which would cause the amp to have no sound. 4. Speaker wire is not making a good contact on the speaker output of the amp or on the speaker terminal. You need to make sure the speaker wire is securely tightened into the speaker terminal and the amplifier terminal. 5. Make sure the positive speaker wire is connected to the positive terminal on the speaker and on the amp, and make sure the negative is connected to the negative. 6. Make sure the gain of the amplifier is turned up.

שאלה 1: מהי תפקידה של התא המטאבולי?

תפקיד התא המטאבולי הוא לייצר אנרגיה עבור התא. הוא עושה זאת על ידי פירוק המזון (גלוקוז) לנתונים קטנים יותר, כמו פירואט, ופירוק פירואט לנתונים קטנים יותר, כמו אצטיל-CoA, שמתחברים לשרשרת הנשימה. תהליכים אלו משחררים אנרגיה בצורת ATP, שהיא מקור האנרגיה העיקרי לתא.

שאלה 2: מהי תפקידה של התא המטאבולי?

תפקיד התא המטאבולי הוא לייצר אנרגיה עבור התא. הוא עושה זאת על ידי פירוק המזון (גלוקוז) לנתונים קטנים יותר, כמו פירואט, ופירוק פירואט לנתונים קטנים יותר, כמו אצטיל-CoA, שמתחברים לשרשרת הנשימה. תהליכים אלו משחררים אנרגיה בצורת ATP, שהיא מקור האנרגיה העיקרי לתא.



ROCKVILLE